



■ Vers.



■ Vers.



■ Vers.



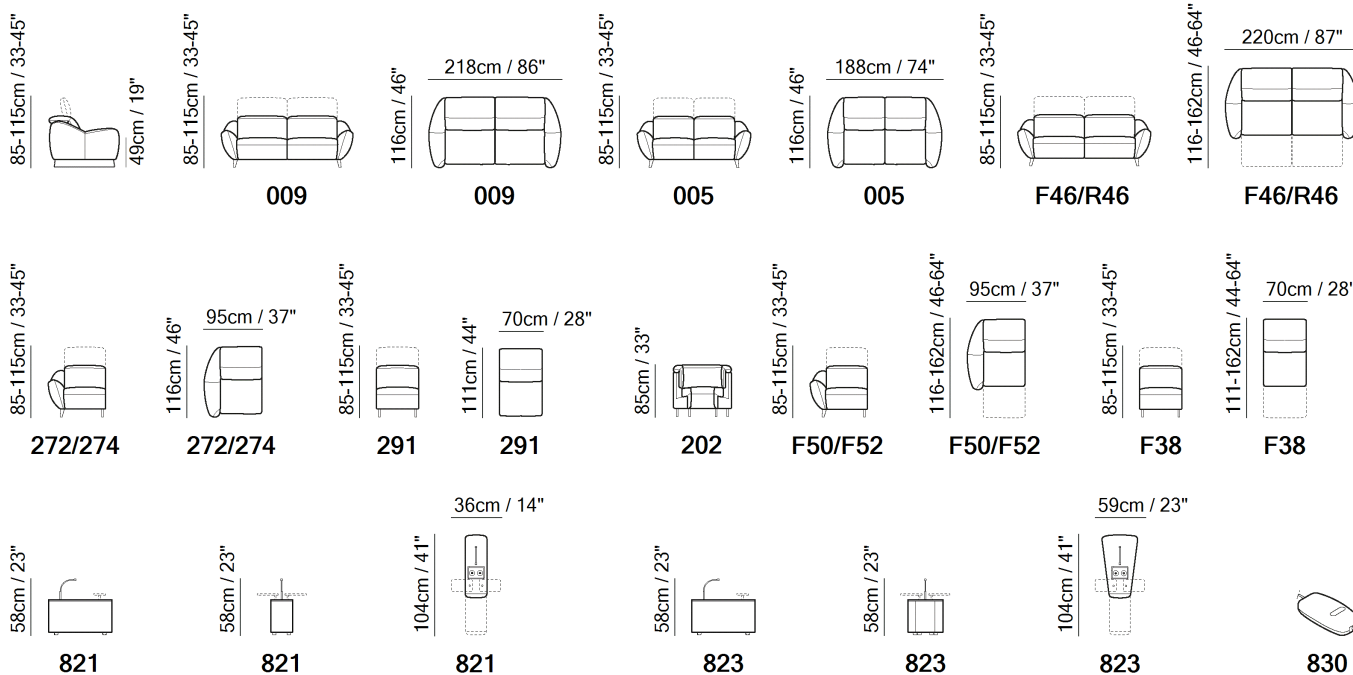

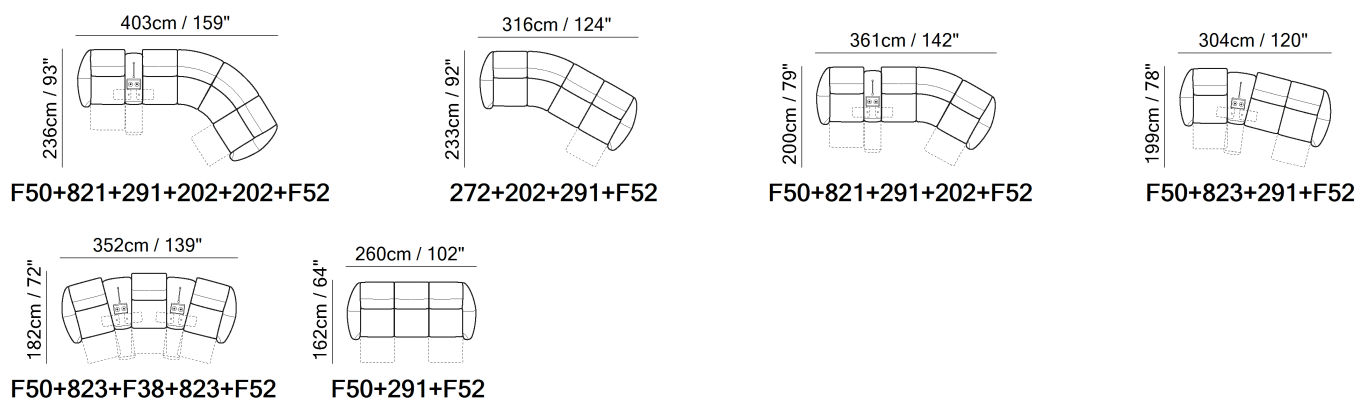

SCHEMATICS



COMPOSITION EXAMPLES



TECHNICAL INFORMATION

	COVERING	Leather <input checked="" type="checkbox"/>	Soft Cover <input checked="" type="checkbox"/>				
	FILLING	Arms	<input type="checkbox"/> Fiber <input type="checkbox"/> Foam <input type="checkbox"/> Feather/Fiber Mix <input type="checkbox"/> Feather	Seat cushion	<input type="checkbox"/> Fiber <input type="checkbox"/> Foam <input type="checkbox"/> Feather/Fiber Mix <input type="checkbox"/> Feather	Back cushion	<input type="checkbox"/> Fiber <input type="checkbox"/> Foam <input type="checkbox"/> Feather/Fiber Mix <input type="checkbox"/> Feather
	COMFORT	Standard Comfort <input checked="" type="checkbox"/>	Firm Comfort <input type="checkbox"/>				
	FUNCTION	Bed <input type="checkbox"/>	Electric motion <input type="checkbox"/>	Motion <input checked="" type="checkbox"/>	Recliner <input type="checkbox"/>	Sliding <input type="checkbox"/>	
	VISUAL APPEARANCE*	Low <input type="checkbox"/>	Medium <input checked="" type="checkbox"/>	High <input type="checkbox"/>			
	LEGS	Wood <input type="checkbox"/>	Metal <input type="checkbox"/>	Plastic <input type="checkbox"/>	Castors <input type="checkbox"/>	Upholstered <input type="checkbox"/>	

VISUAL APPEARANCE

The product may reveal various wrinkles due to the combination of Elasticity of the covering, characteristics of the interior construction and the design of the product.



Products with Visual Appearance listed as High or Medium would require higher degree of care, where seats and back cushions may require fluffing and plumping more often than Products with Visual Appearance listed as Low.

NOTES

- Available in leather (TG only) or fabric.
- By distributing weight evenly across all pressure points, the zero-gravity power motion system makes you feel weightless. It takes the pressure off your spine and can promote circulation in the legs.
The definition of Zero Gravity Reclining is the ability for your heart to be resting above your feet which provides proven health benefits.
- ZERO GRAVITY™ DUAL POWER MOTION: a unique power motion system that separately and independently activates the different functions, to adjust the seat recliner and the headrest, allowing you to reach extreme comfort in a “zero gravity” position.
- Switch #1: All in One Power Reclining mechanism that simultaneously reclines the back, activates a “comfort tilt” of the seat and a full extension of the footrest, taking you to a “zero gravity” position that will make you experience a total and unparalleled relaxation.
- Switch #2: Power Adjustable Headrest which allows you to recline the headrest forward with millimetric precision to support you with a perfect and proper posture.
- «DualPower Motion» mechanism “All -in-One” power motion system offers a seamless, continuous sequence of functions designed to provide optimum comfort:
 - it starts by adjusting the headrest
 - then reclines both the seat and backrest,
 - and concludes with a final forward tilt of the headrest.

NOTES

- The dual power motion feature is controlled via concealed smart touch buttons positioned between the seat and the armrest.

Footboard closure design: The specific design of the footboard closure with its extended flap further contributes to optimal relaxation while also providing a spacious open base beneath the sofa, making cleaning easier.

- The multifunctional console, with a full wooden finish, features a spacious tabletop, a storage drawer, a built-in USB port, and connectors for adding optional features—blending style, convenience, and versatility. The console can be ordered with its own version code 821 or 823. For order entry please use XXX for alias code and finishing code ST49 ash brown or ST50 ash blonde.
- A battery pack can be ordered with its own version code 830. For order entry please use XX for category and XXX for cover code. In order to optimize the duration of the battery, it is suggested to order one per each motion seat.
- Internal wooden frame.
- Feet will be in a bag inside the package and requires assembling.
- Packaging: Cardboard wrap.
- Feet are available in metal leg finishings (79 matt black or 70 brushed brass)